

NEPEAN Power is a proven leader in the supply and manufacture of quality engineered solutions, products and technologies. Established in 1994, through the commitment of our dedicated team we have become a supplier of choice.

NEPEAN Power's Resistance Temperature Detectors (RTD's) have a well deserved reputation in the industry for their superior stability and accuracy. RTD PT100 sensors are an industry standard sensor made of platinum, which has a 100 ohm resistance at 0°C and a temperature co-efficient (alpha) of 0.00385 ohm/°C.

**AVAILABLE FROM
NEPEAN ELECTRONICS**

Stocked Parts/Quick Order Guide

Part Number	Type	Description
X0014-M8-3-2-1	Bolt	PT100 M8 x 30mm, 2m stainless steel armour, 1m tail
X0014-M8-3-5-1	Bolt	PT100 M8 x 30mm, 5m stainless steel armour, 1m tail
X0150-6-200-2-1	Probe	PT100 RTD Probe 6mm x 200mm, 2m stainless steel armour, 1m tail (suits compression fitting)
X0150-6-200-5-1	Probe	PT100 RTD Probe 6mm x 200mm, 5m stainless steel armour, 1m tail (suits compression fitting)
X0150-6-270-2-1-R	Probe	RTD (PT100) Probe 6mm X 270mm right angle cable exit 2M S/S 3M OVERALL

Compression Fittings

Part Number	Description
X0203	RTD COMP FITTING inner diameter D=6mm, external thread E=1/4BSP, stainless steel
X0204	RTD COMP FITTING inner diameter D=6mm, external thread E=1/2BSP, stainless steel
X0215	RTD COMP FITTING inner diameter D=3mm, external thread E=1/4BSP, stainless steel
X0271	RTD COMP FITTING inner diameter D=6mm, external thread E=M12, 1.75 pitch, stainless steel

Transmitters

Part Number	Description
X0429	PT100 Signal Isolated Transmitter 0-150Deg, 24Vdc, 4-20mA

Bolt Type RTD PT100

These are standard bolts (stainless steel, unless requested otherwise), with the sensing element drilled into the head of the bolt to be just short of the end of the thread. Typical diameters are M8, M10, or M12 and lengths of 30 to 100mm.

Part Number Generator

X0014 - MXX - XX - X - X

Thread Diameter
M8 = 8mm
M10 = 10mm
M12 = 12mm

Thread Length
3 = 30mm (min)
4 = 40mm
etc
10 = 100mm (max)

Tail Length
1 = 1m
2 = 2m
3 = 3m
etc

Armour Length
1 = 1m
2 = 2m
3 = 3m
etc

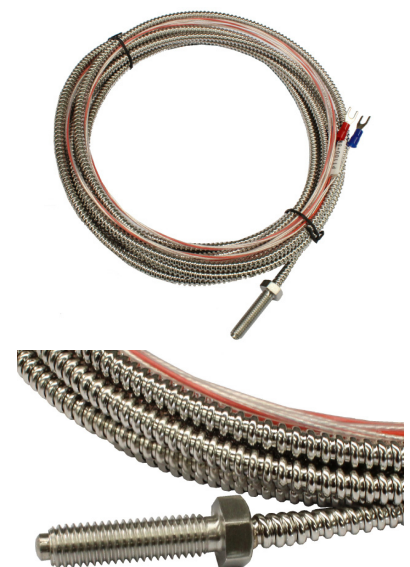

RTD Sensors

Probe Type RTD PT100

Probes come in various sizes: diameter, length, mounting type and mounting thread, straight or right angle mounted. We also provide customized solutions. Please specify diameter and length from mounting point, standard diameters would be 3, 6 and 8mm with lengths up to 1M. Compression fitting allowing the probe to be slide in or out.

Part Number Generator

X0150 - X - XXX - X - X - X

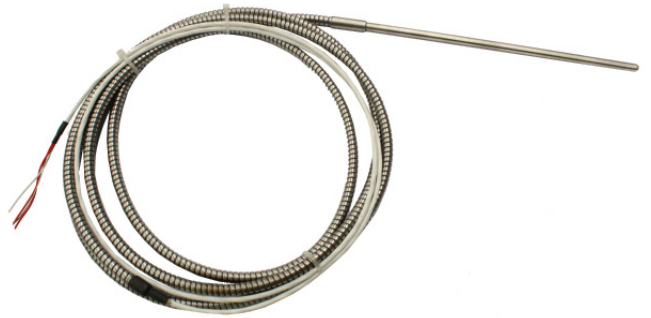
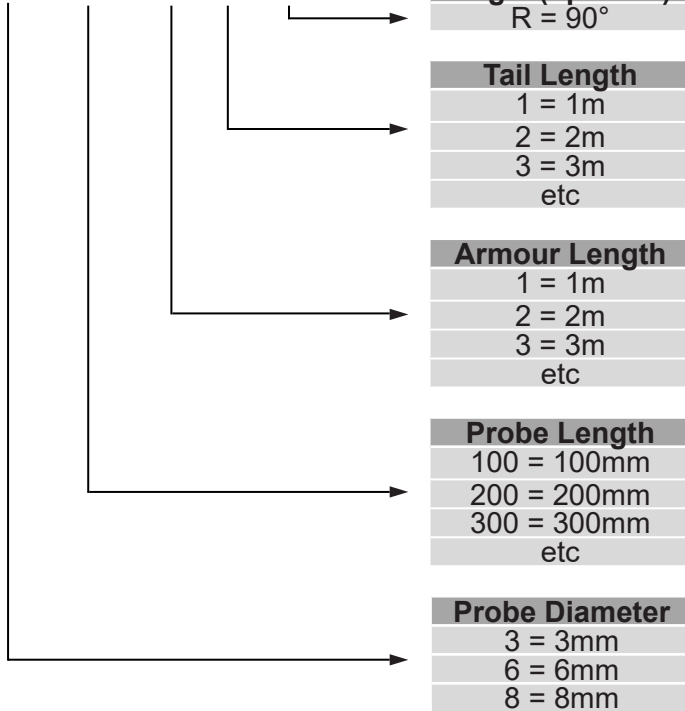

Washer Type RTD PT100

This type of probe can be mounted under a bolt head like a washer. Typical sizes are M6 to M20. These are supplied as flying lead type only.

X0134 - MX - X - X

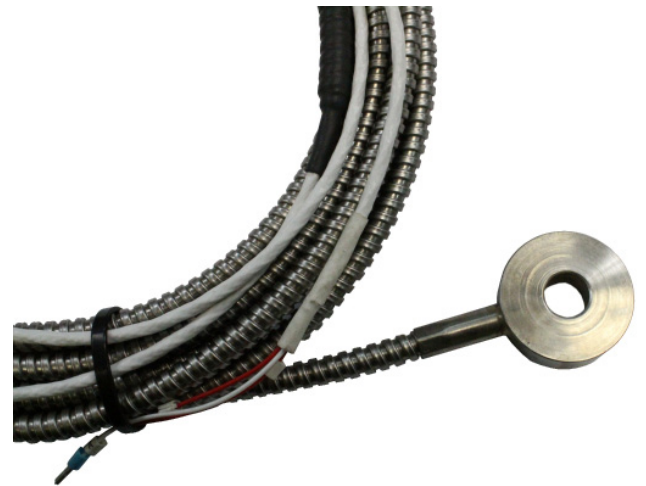
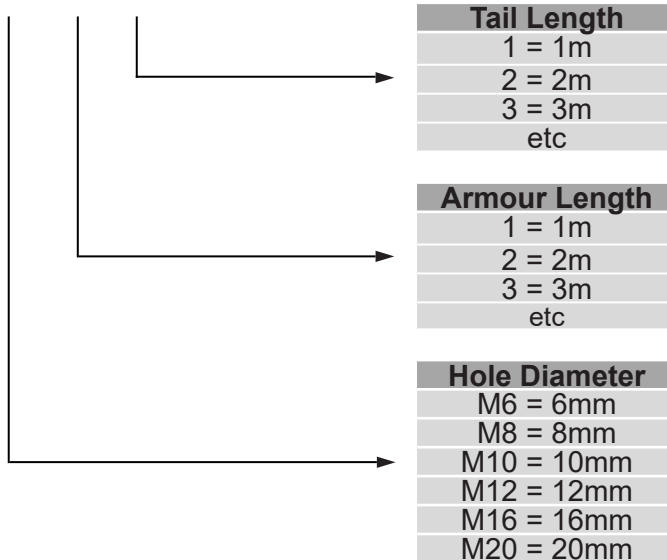

NEPEAN
Power

www.nepeanpower.com

For more information please contact:

P: +61 2 4088 2790

E: power@nepean.com

RTD Sensors

Head Type RTD PT100

Head types can be purchased with or without the 4-20mA transmitter.



X0351 - With Thread

Supplied complete with X0429 transmitter.

X0351 - X - XXX - X - X

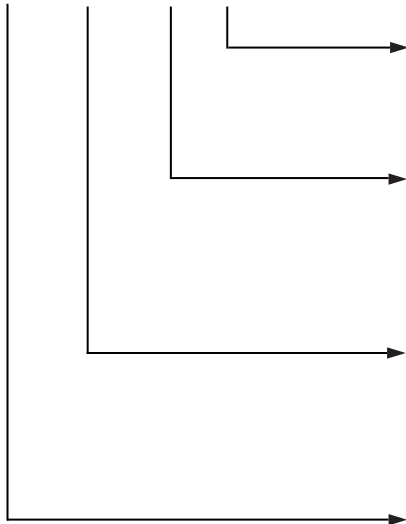

Head Diameter
90 = 90mm
150 = 150mm

Probe Diameter
3 = 3mm
6 = 6mm
8 = 8mm

Probe Length
100 = 100mm
200 = 200mm
300 = 300mm
etc

Mounting Type
M8 = 8mm
M10 = 10mm
M12 = 12mm

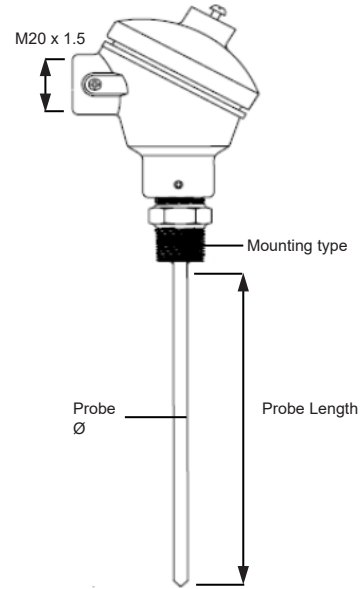

X0352 - No Thread (suits compression fitting)

Supplied complete with X0429 transmitter. Compression fitting not included.

X0352 - X - XXX - XX

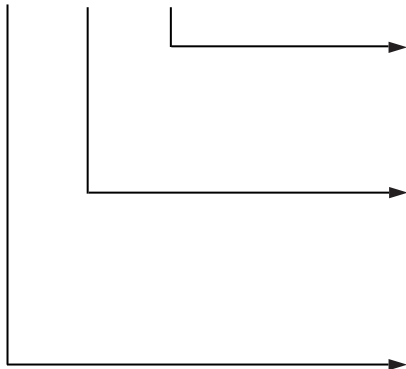

Head Diameter
90 = 90mm
150 = 150mm

Probe Length
100 = 100mm
200 = 200mm
300 = 300mm
etc

Probe Diameter
3 = 3mm
6 = 6mm
8 = 8mm

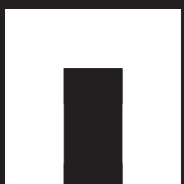
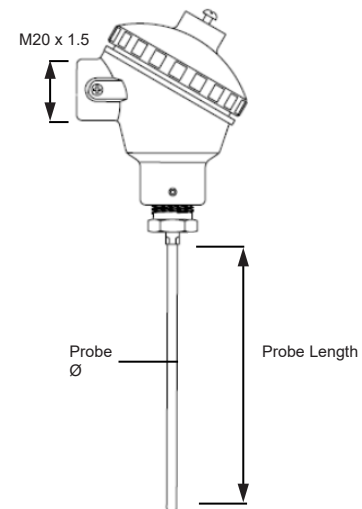

NEPEAN
Power

www.nepeanpower.com

For more information please contact:

P: +61 2 4088 2790

E: power@nepean.com

RTD Sensors

Compression Fitting

RTD's are used to fix probes to the device, pipe. It contains a ferrule to accommodate your desired probe diameter. The internal diameter is typically 3 or 6mm, and the mounting thread (BSP), typically 1/4BSP.

Part Number	Thread	Shaft (x)	Diagram
X0215	1/4 inch BSP	3mm	A
X0203	1/4 inch BSP	6mm	A
X0204	1/2 inch BSP	6mm	B
X0271	M12	6mm	C

Diagram A

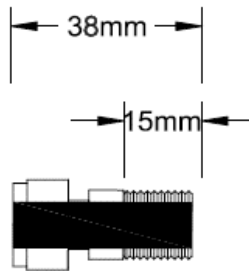

std 1/4" BSPT to 6mm compression fitting

Diagram B

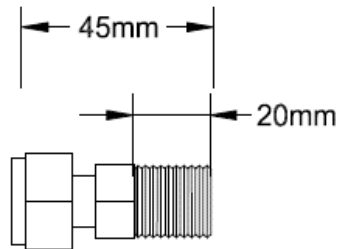

std 1/2" BSPT to 6mm compression fitting

Diagram C

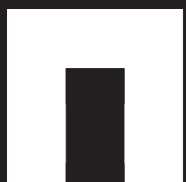
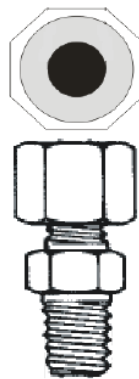

NEPEAN
Power

www.nepeanpower.com

For more information please contact:

P: +61 2 4088 2790

E: power@nepean.com